

# Rockfon System C

Installation system

# Rockfon System C

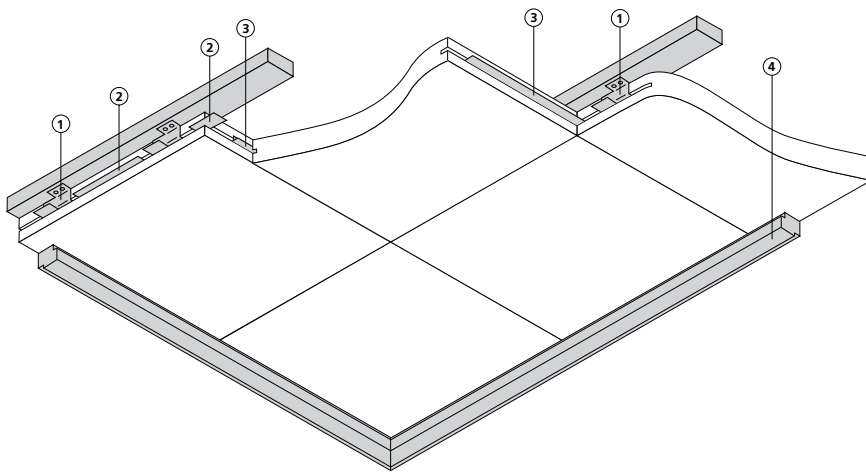

*NB: Illustration shows one of the many layout options.*

Rockfon products with edge detail C are suitable for installation using this system.

Rockfon System C is a direct fix installation method for installing Rockfon tiles with edge detail C. It comprises concealed galvanized steel hooks and splines.

When installing tiles using this system, both aligned and offset patterns can be created. Due to the small installation depth required, the finished ceiling height can be maximised.

The following ceiling tile module sizes (mm) can be used with

System C:

600 x 600

1200 x 600

1200 x 300 mm.

## **System Loading Capacity**

Additional loads must not be placed on the tiles. All loads should be transferred to the soffit / substrate. Due to the potential for large wind loadings, this system is not recommended for use as a lining to the underside of a ventilated roof space.

# Ceiling layout & system components

## Ceiling layout options

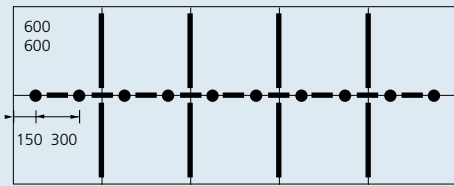

Aligned pattern 600 x 600 mm

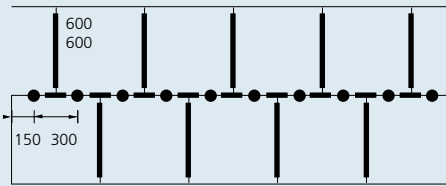

Offset pattern 600 x 600 mm

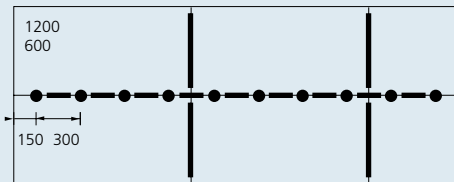
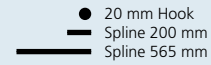

Aligned pattern 1200 x 600 mm

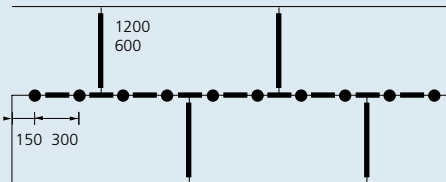

Offset pattern 1200 x 600 mm

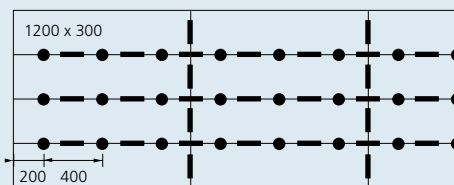

Aligned pattern 1200 x 300 mm

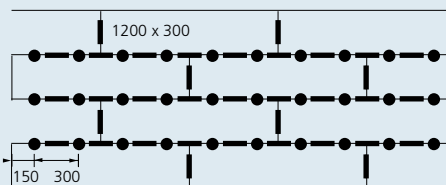

Offset pattern 1200 x 300 mm

System components and consumption guide				
Quantity/m <sup>2</sup>	①	②	③	④
	20 mm Hooks	Spline L: 200 mm	Spline L: 565 mm	Perimeter Trim
<b>Module size (mm)</b>				
Reference	RHR701-18	H465190	H42211	
600  (Aligned pattern)	5.6 pcs	5.6 pcs	2.8 pcs	1)
1200  (Aligned pattern)	5.6 pcs	5.6 pcs	1.4 pcs	1)
1200  (Aligned pattern)	8.4 pcs	8.4 pcs		1)
600  (Offset pattern)	5.6 pcs	5.6 pcs	2.8 pcs	1)
1200  (Offset pattern)	5.6 pcs	5.6 pcs	1.4 pcs	1)
1200  (Offset pattern)	11.2 pcs	13.9 pcs		1)

Minimum installation depth		
Tile thickness (mm)	Module size (mm)	D (mm)
20	600 x 600 1200 x 600 1200 x 300	24

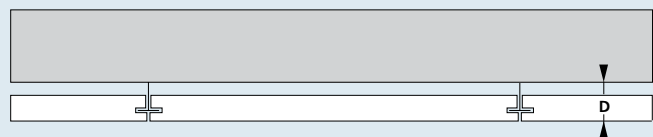

1) Consumption according to room size.

# Perimeter finish options

Here are some options for perimeter finishing:

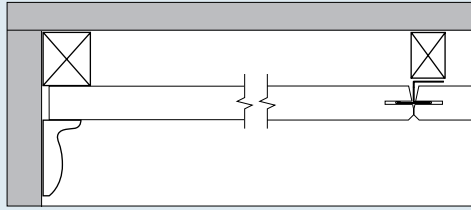

**1.** *Timber moulding*

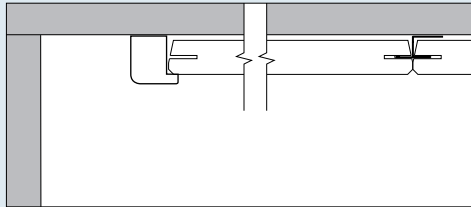

**2.** *Timber moulding*

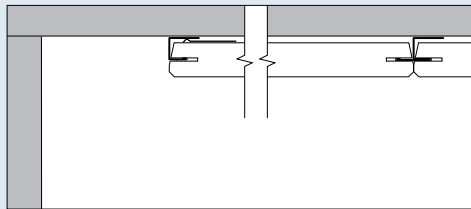

**3.** *U profile*

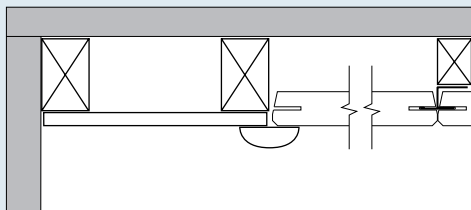

**4.** *Plain gypsum border*

# Installation guide & Service integration

## Perimeter Finishing

### Junction between ceiling and wall or other vertical / horizontal surface

The perimeter trim should be fastened to vertical or horizontal surfaces at the required level using appropriate fixings at nominal 450 mm centres. Ensure that butt joints between adjoining lengths of trim are neat and that the trim is free from kinks and remains true and level. For the best aesthetics, use as long a length of trim as possible. The minimum recommended cut length is 300 mm.

Specially made timber trims or mouldings are ideally suited for use as the perimeter finish with this system.

When installing this system, it is recommended to install perimeter trims on a maximum of three sides of the area prior to commencing installation of the tiles. The remaining trim can then be installed after the last row of tiles.

### Junction between ceiling and curved vertical surface

The use of a preformed curved perimeter trim is the most appropriate method. This should be installed as described above. Specially made curved timber trims are recommended.

### Corners

Perimeter trims should be neatly mitred at all corner joints.

## Hooks & Tiles

Unless specified otherwise, the ceiling should be set out symmetrically and where possible, perimeter tiles should be greater than 200 mm in width.

It is important to ensure that the soffit/substrate is smooth and level. Alternatively, levelling can be achieved by first fastening timber battens (recommended minimum width 25 mm) at tile module centres to the soffit prior to fastening the hooks.

Fasten the first row of hooks to the soffit with appropriate fixings in the prepunched holes. Ensure that the hooks are in full alignment.

Install the first tile into the hooks, and then install the splines into the tile edges. This procedure should be followed to install the remaining hooks, splines and tiles.

The last row of tiles should be installed by allowing for a 14 mm gap between the wall and tiles. The cut edge of the perimeter tiles can be temporarily held in position with a small nail prior to the fastening of the last section of perimeter trim.

NB. If fixing to timber battens, and the perimeter tiles have to be cut to less than full module size, the last perimeter timber batten shall be adjusted so that it is 4 mm thicker than the other timber battens. This ensures that the ceiling is level and flat. The cut perimeter tiles can then be temporarily held in position as described above.

### Tile installation

When installing the tiles, the use of gloves is recommended. Ensure that the tiles are level and installed in a straight line. Rockfon tiles are easy to cut using a sharp knife. Apply Rockfon edge paint on all visible cut edges.

## Service integration

Rockfon tiles with edge detail C installed using System C should not be used for supporting light fittings or similar services. Installations should be fixed through to the firm substrate. Alternatively, lights etc can be cut into the tile and then fixed to the soffit / substrate.

### Light integration

See datasheet for guideline on installation of spotlights and recessed modular lights.

# ACTIVATE YOUR CEILING

Rockfon® develop intelligent ceiling solutions which actively address a number of important issues in modern buildings and renovation projects.

Rockfon products are known for their design, aesthetics and ease of installation; coupled with the key performance features of superior fire resistance and acoustics.

This ensures that our ceiling solutions are among the highest performing, most cost effective and time efficient in today's interiors market.

The comprehensive ceiling solution portfolio from Rockfon ensures that our customers are able to actively add value to the construction process, by ultimately creating superior interior environments.

That is why we say "ACTIVATE YOUR CEILING".

## Rockfon Limited - a Rockwool Company

26 – 28 Hammersmith Grove  
Hammersmith  
London W6 7HA

Tel: +44 (0)20 8222 7457  
Fax: +44 (0)20 8222 7458

[www.rockfon.co.uk](http://www.rockfon.co.uk)



### Specification

The ceiling grid system shall be Rockfon System C, installed to form a module of \_\_\_\_\_ x \_\_\_\_\_ mm in aligned / offset\* pattern.

The tiles shall be fastened to the structural soffit using 20 mm hooks at \_\_\_\_\_ mm centres.

The perimeter finish shall be perimeter finish option \_\_\_\_\_.

\*Complete and delete options as required.

NBS K40 specification texts are available either from NBS Plus on 0845 456 9594 or direct from Rockfon.